

Article number: 03504020

Description: Fluro Rod end GE 20LO

Measures

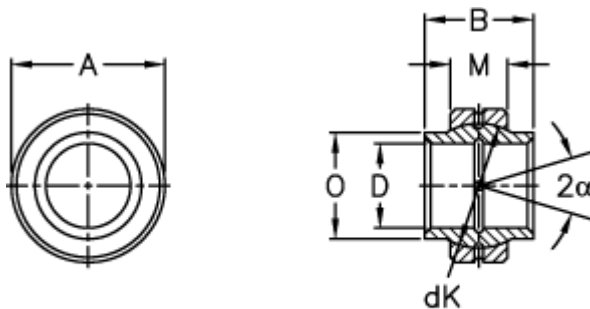

Str. 12 den smørerille

A	= 35 0 -0,011	Tilt angle = 4
B	= 20	Weight = 67
D	= 20 0 +0,021	
dK	= 29	
Dynamic load C (kN)	= 30	
M	= 12	
O	= 25	
Static load C0 (kN)	= 146	